

Montageanleitung Assembly instructions

# i.Sense:module II

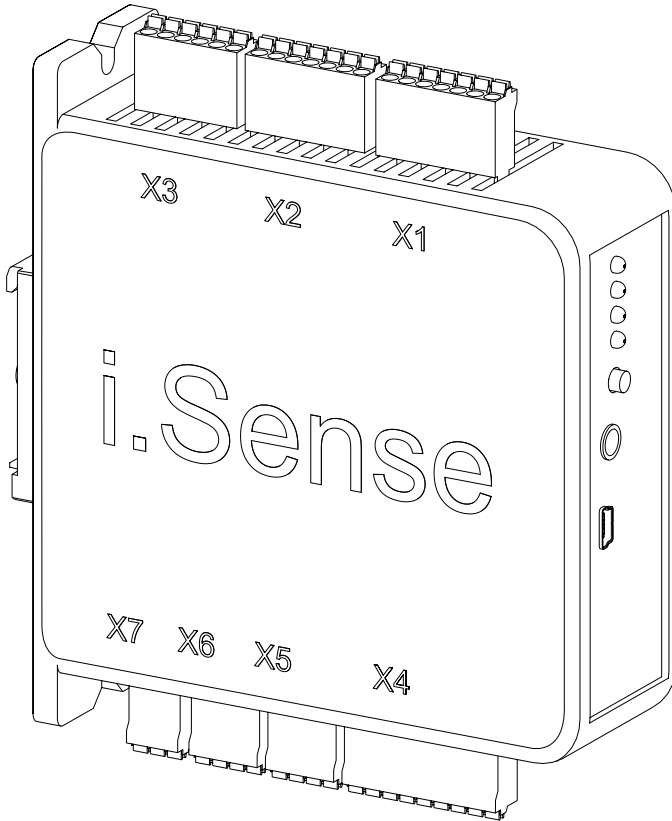

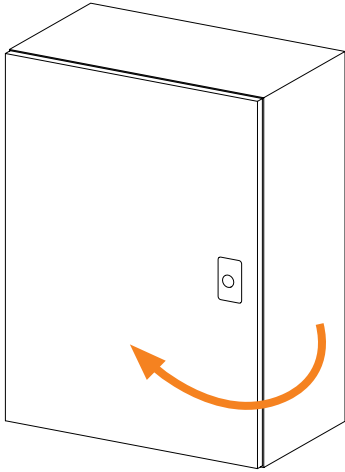

1

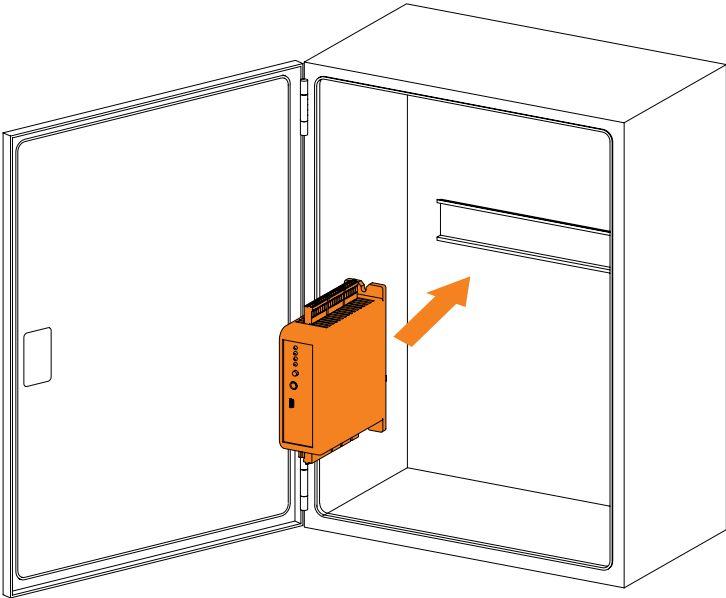

2

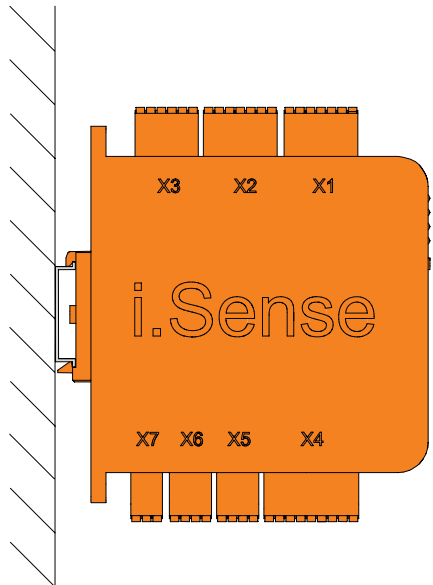
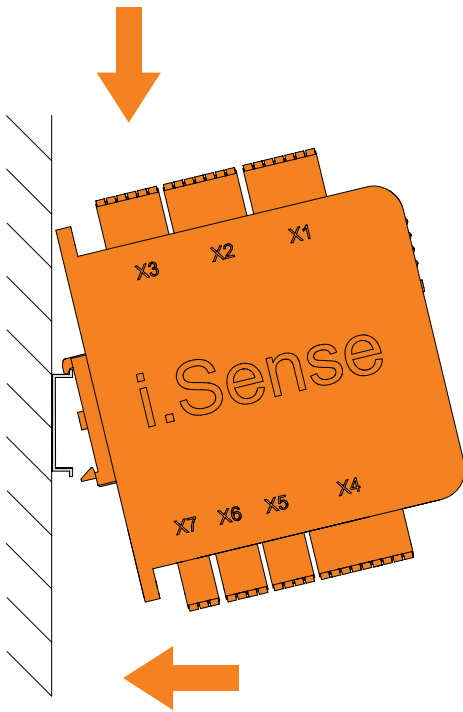

3

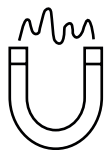
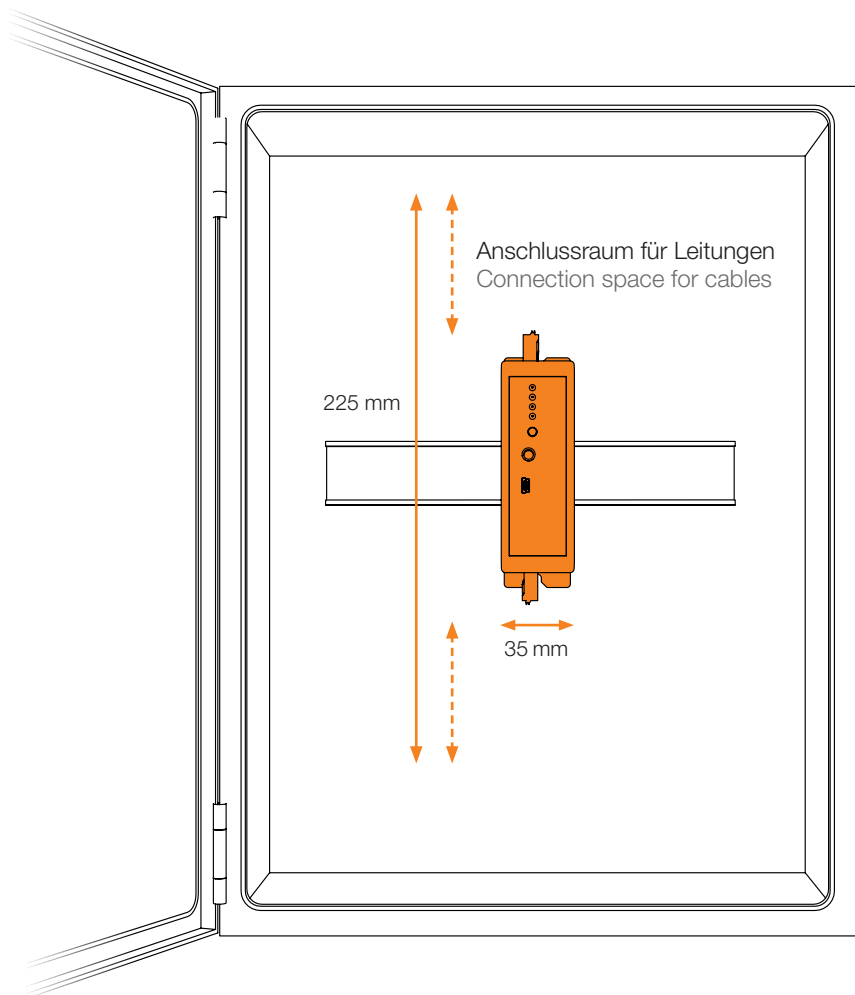

Empfehlung: Nicht in der Nähe von Leistungselektronik wie Frequenzumrichtern platzieren.

Recommendation: Do not place near power electronics, such as frequency converters



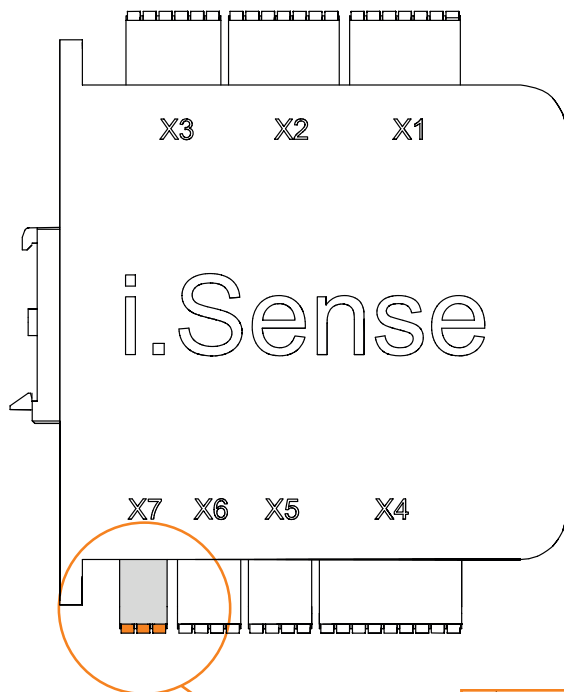

Spannungsversorgung  
Power supply

Terminal	Function
X7 - 1	Functional Earth
X7 - 2	GND
X7 - 3	24 V DC

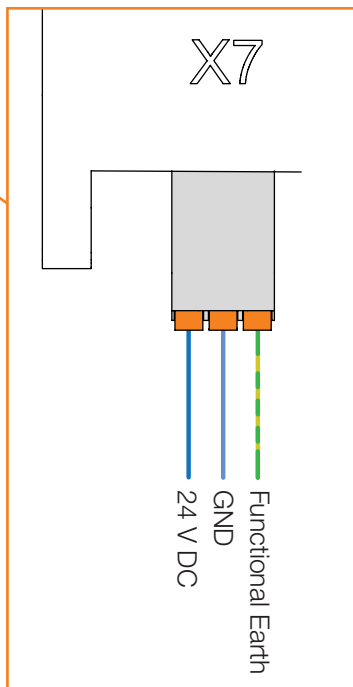

Anschluss von externen Komponenten  
Connection of external components

- a) Sensorik  
Sensorics

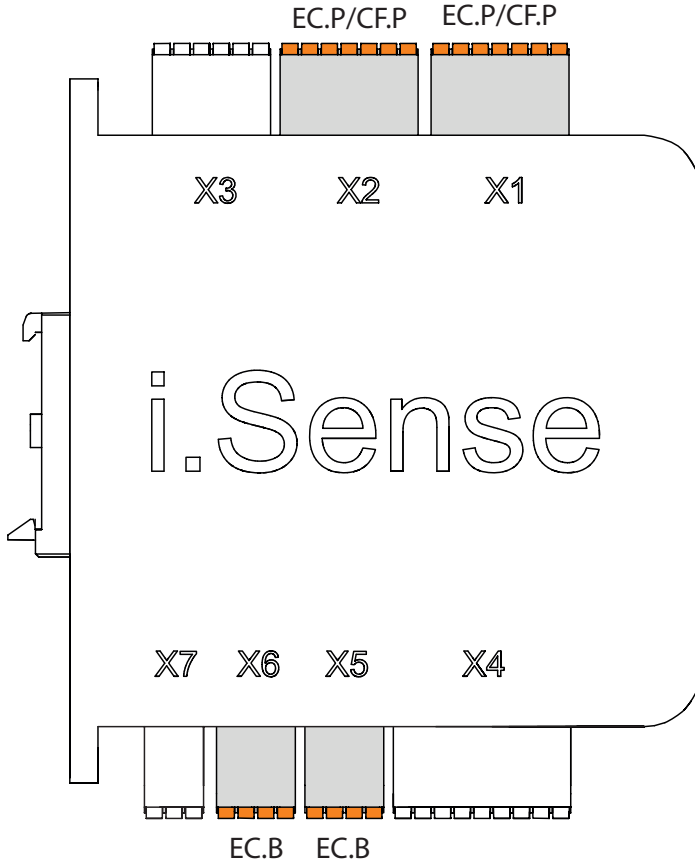

b) Kommunikationseinheit  
Communication unit

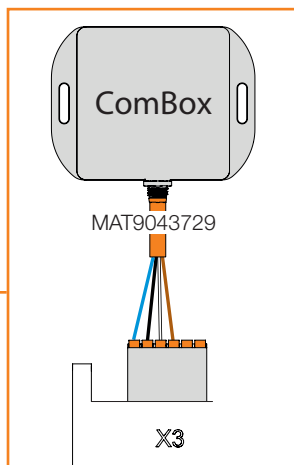
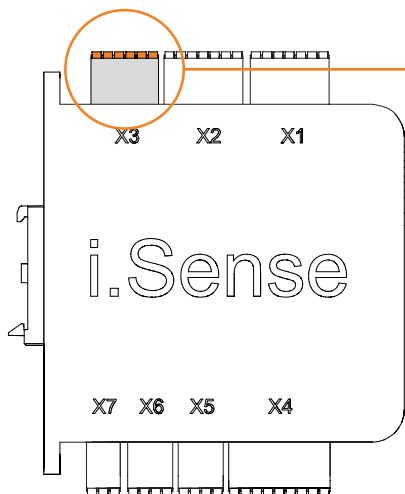

Terminal	Function	Wire color MAT9043729
X3 – 3	5,0 V	Brown
X3 – 4	TX	White
X3 – 5	RX	Black
X3 – 6	GND	Blue

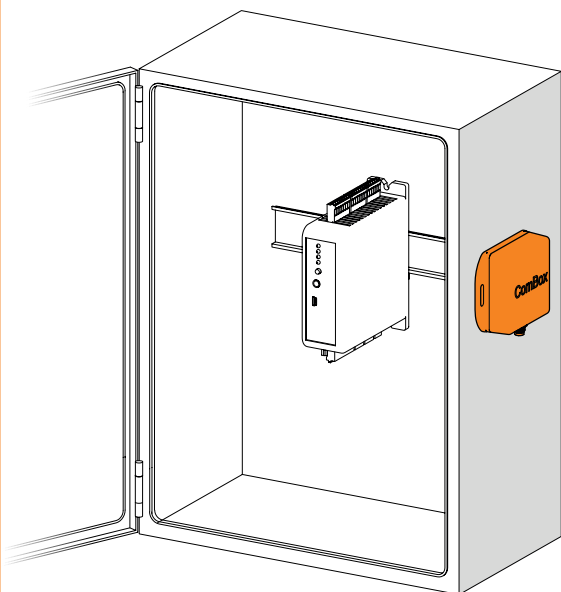

ComBox möglichst außerhalb  
des Schaltschranks montieren  
Install the ComBox outside the  
control cabinet if possible

c) SPS  
PLC

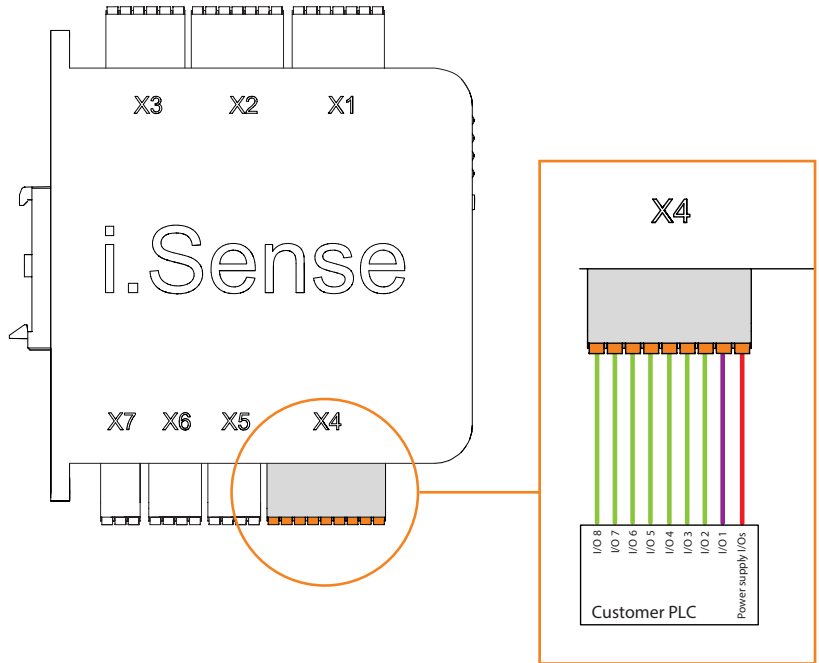

Terminal	Function	Characteristic
X4 – 1	Input for pot.-free contact	(e.g. 24 V DC)
X4 – 2	OUT 1	
X4 – 3	OUT 2	Only IS.EC.U04.05.01.0
X4 – 4	OUT 3	Only IS.EC.U04.05.01.0
X4 – 5	OUT 4	Only IS.EC.U04.05.01.0
X4 – 6	OUT 5	Only IS.EC.U04.05.01.0
X4 – 7	OUT 6	Only IS.EC.U04.05.01.0
X4 – 8	OUT 7	Only IS.EC.U04.05.01.0
X4 – 9	OUT 8	Only IS.EC.U04.05.01.0

# Dashboardnutzung Use of the dashboard

## a) USB

6

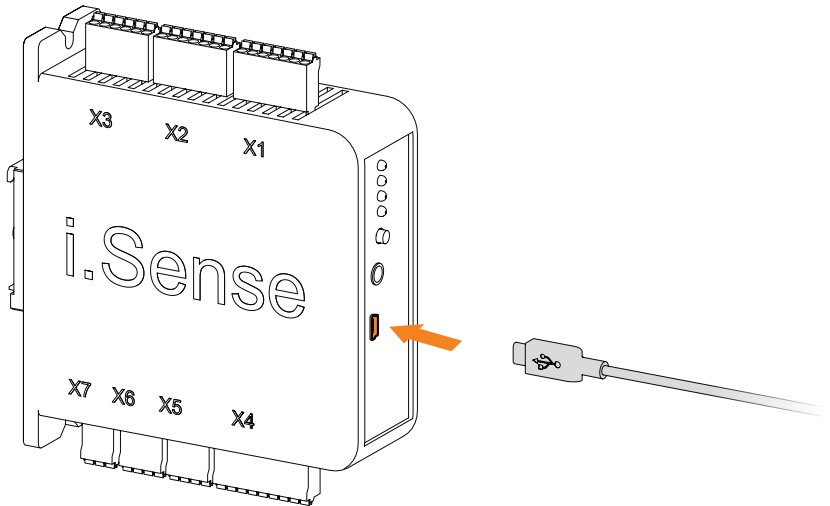

RNDIS-Treiber benötigt  
RNDIS driver needed

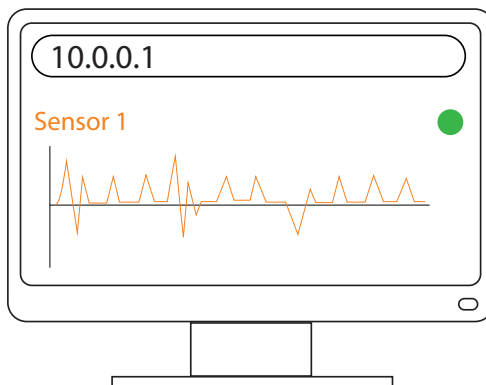

b) Wifi

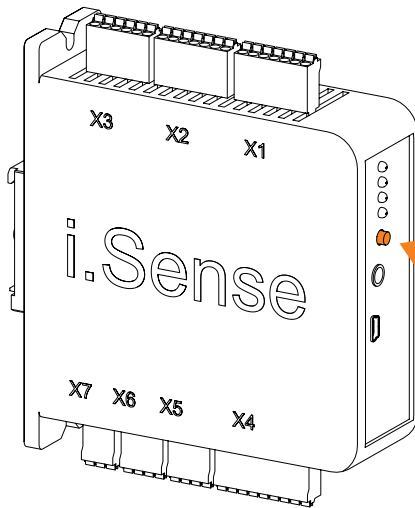

Wifi: 10 Sek drücken  
Wifi: press 10 sec

[serial-number] auf dem  
Barcode auf der Rück-  
seite des Gehäuses

[serial-number] on the  
barcode on the back of  
the case

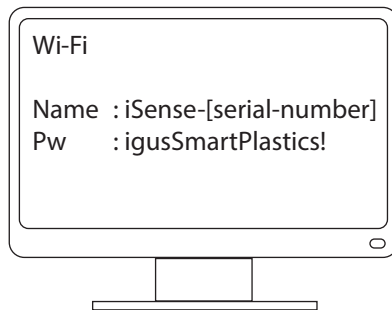

10.0.0.1 in den Browser eingeben  
Typ in 10.0.0.1 in browser

username: igus  
password: igus\_1432#

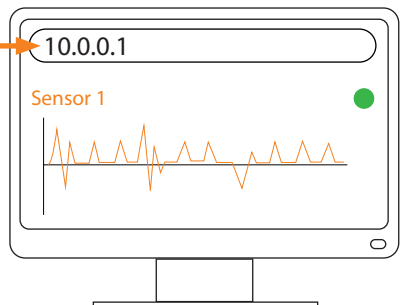

- c) Link zu iCee (optional)  
Link to iCee (optional)

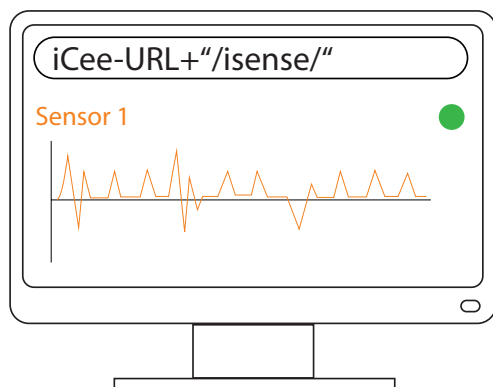
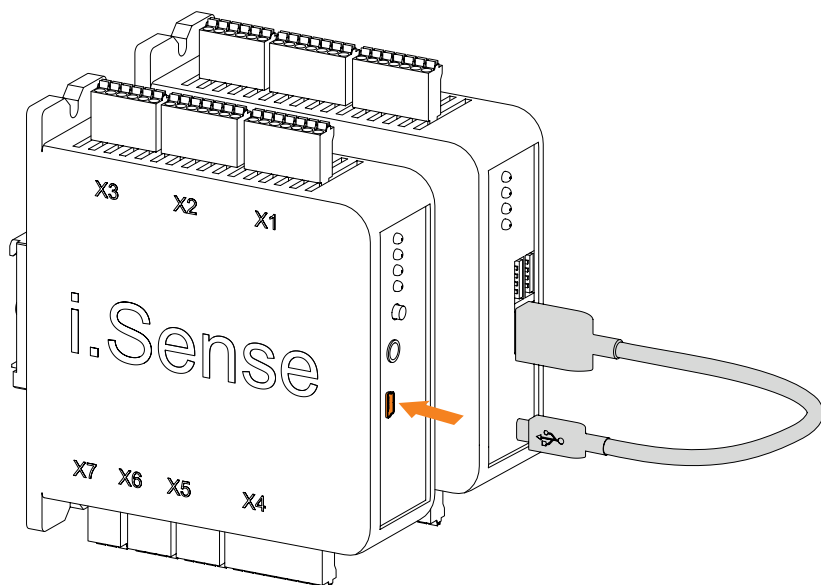

- d) superwise silber (ComBox)  
superwise silver (ComBox)

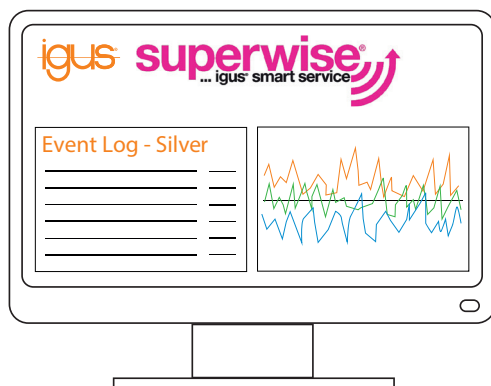
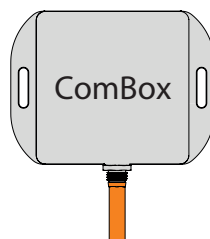
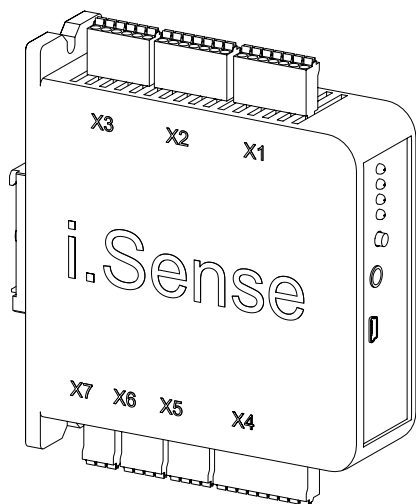





**iglus® SE & Co. KG**  
**Spicher Str. 1a**  
**51147 Köln Cologne**  
**Tel. +49 2203 9649-145**  
**Fax +49 2203 9649-334**  
**info@iglus.de**  
**www.iglus.de**  
**www.iglus.eu**

**© iglus® SE & Co. KG**

Herausgeber ist die iglus® SE & Co. KG, Deutschland  
Published by iglus® SE & Co. KG, Germany  
MAT0076076.25 Stand Issue 01/2026  
Technische Änderungen vorbehalten  
Subject to technical alterations